

Inlet:
Male ISO 228-1 G1/2"

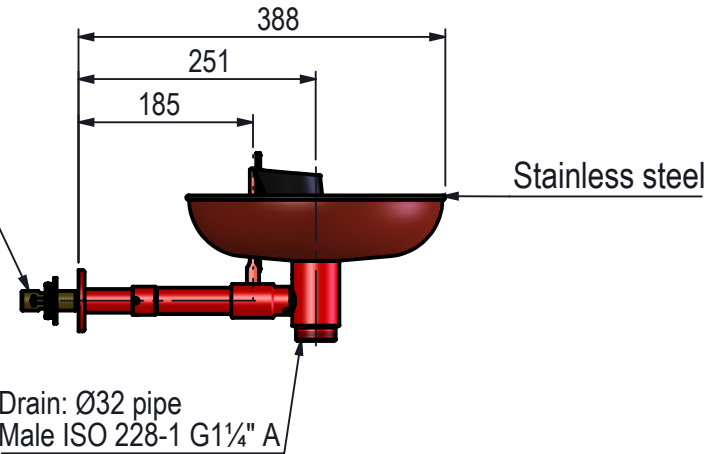

Stainless steel

Drain: Ø32 pipe
Male ISO 228-1 G1 1/4 A

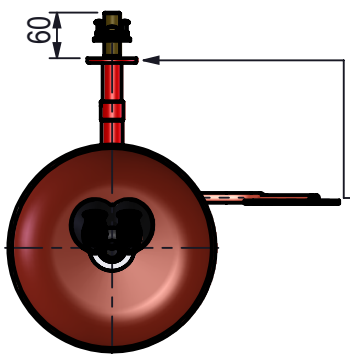

Wall Flange

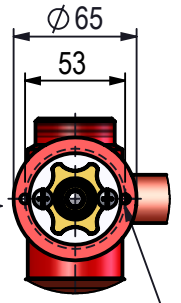

(2 x)

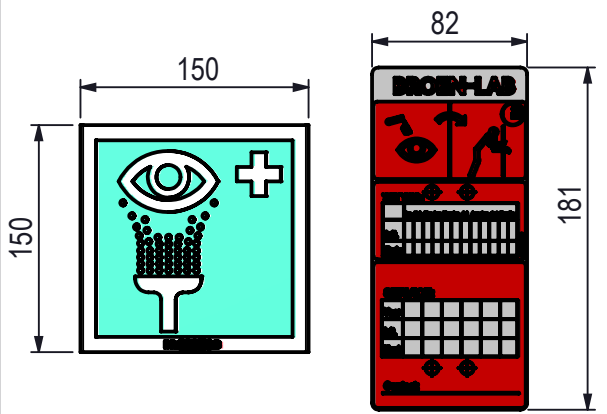
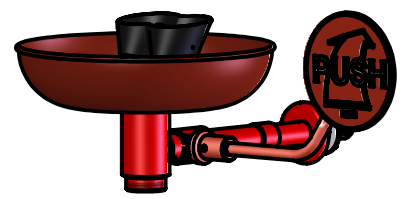
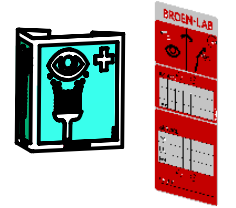
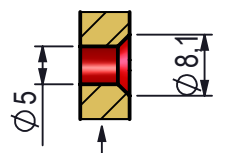

Description:		Eye shower with bowl, wall mounted.	
Media:		Water	
Material:			
Specification:			
Comments:			
Drawing type:		Customer drawing	Weight: 3.283 Kg
All dimensions made with are inspection dimensions			
Unspecified linear tolerances:		Unspecified angular tolerances:	
Designed by:	Drawn by:	Released on TM No.	Date:
HEM	AAH		21-10-16
Format:	Drawing No.:		17533009C
A4			

Rev.	Pos.	Date	TM No.	Design by	Drawn by:	Change:

BROEN-LAB This drawing is our property and cannot be given to a third party, copied or otherwise used without our permission. BROEN-LAB A/S

